

Kos 2DivCo

ASSEMBLY / MONTERING

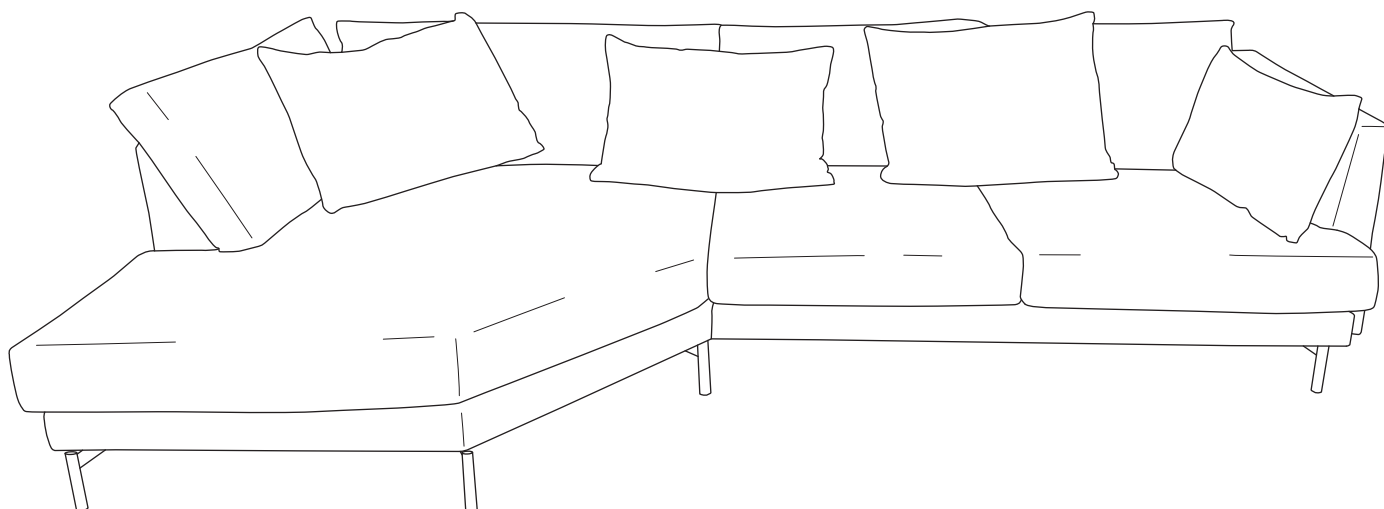

YOU NEED / DU BEHÖVER

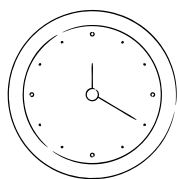

ca 30 min



2 persons / 2 personer

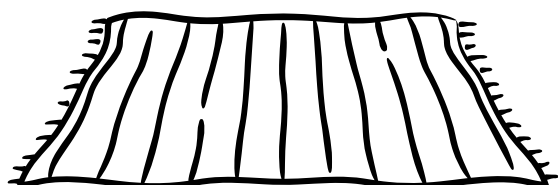
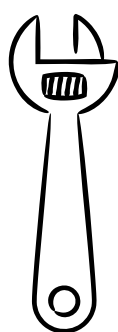
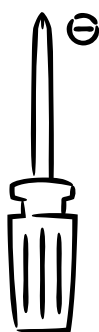

Place your product on a soft surface when assembling.

Lägg dina produkter på ett mjukt underlag när du monterar.

PARTS / DELAR

	Qty / Antal
A	7
B	28
C	7
E	2
F	1

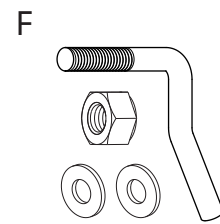
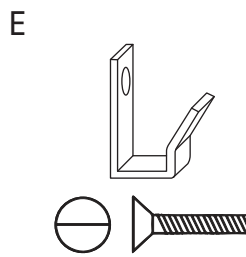
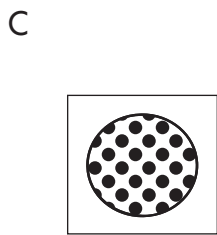
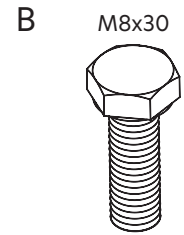
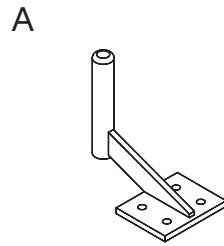

	Qty / Antal
D	7
C	7
E	2
F	1

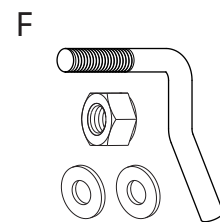
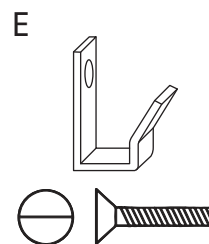
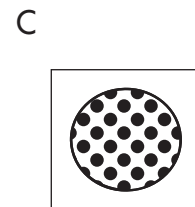
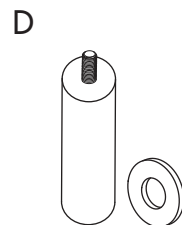

ASSEMBLY / MONTERING

Follow the instruction step by step.

Följ instruktionerna steg för steg.

1.

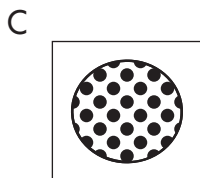
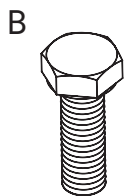
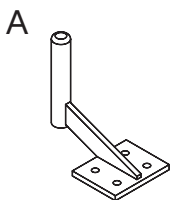
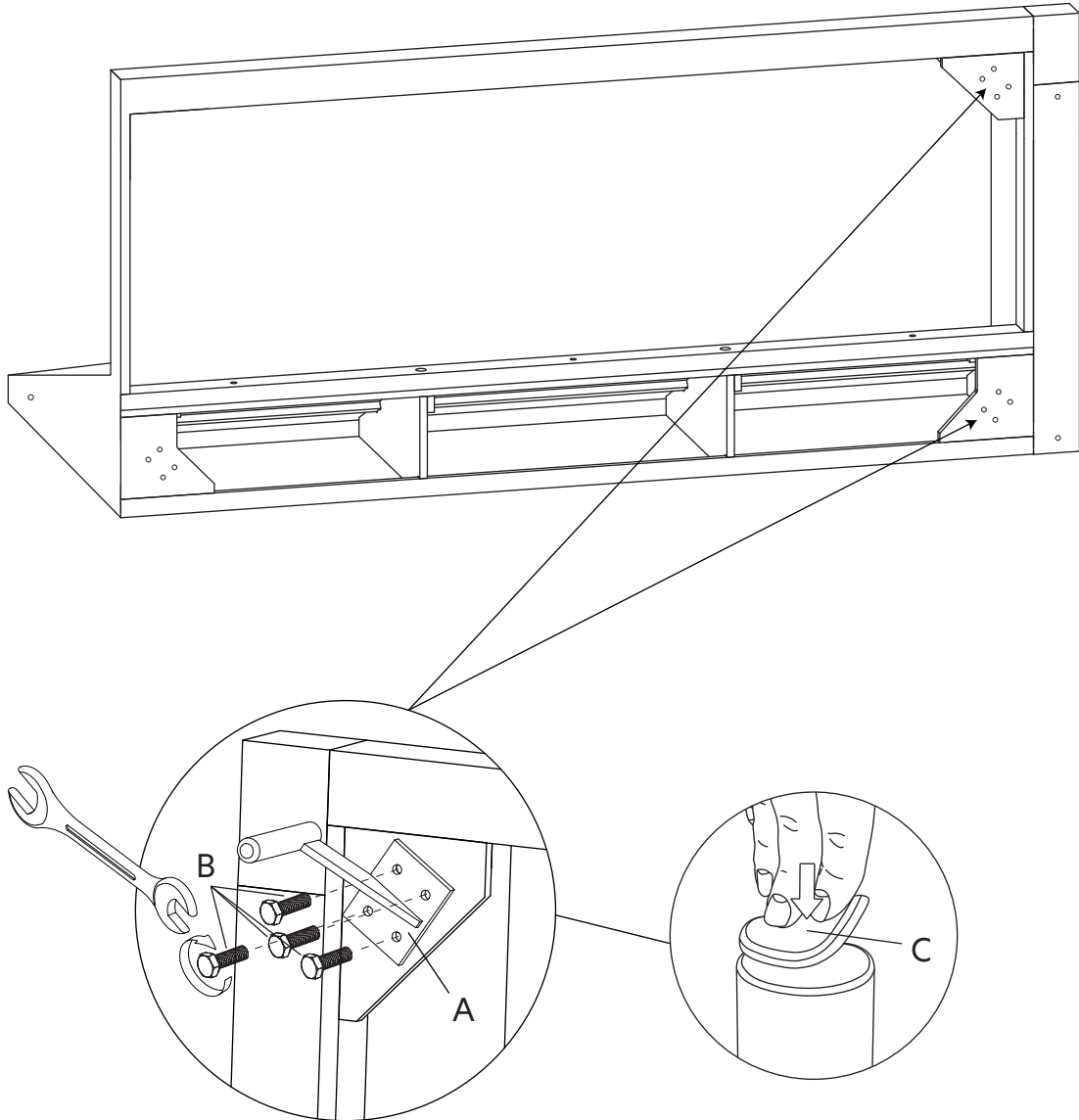

ASSEMBLY / MONTERING

Follow the instruction step by step.

Följ instruktionerna steg för steg.

2.

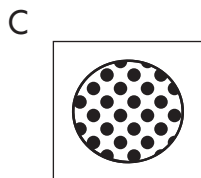
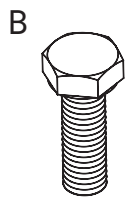
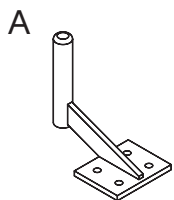
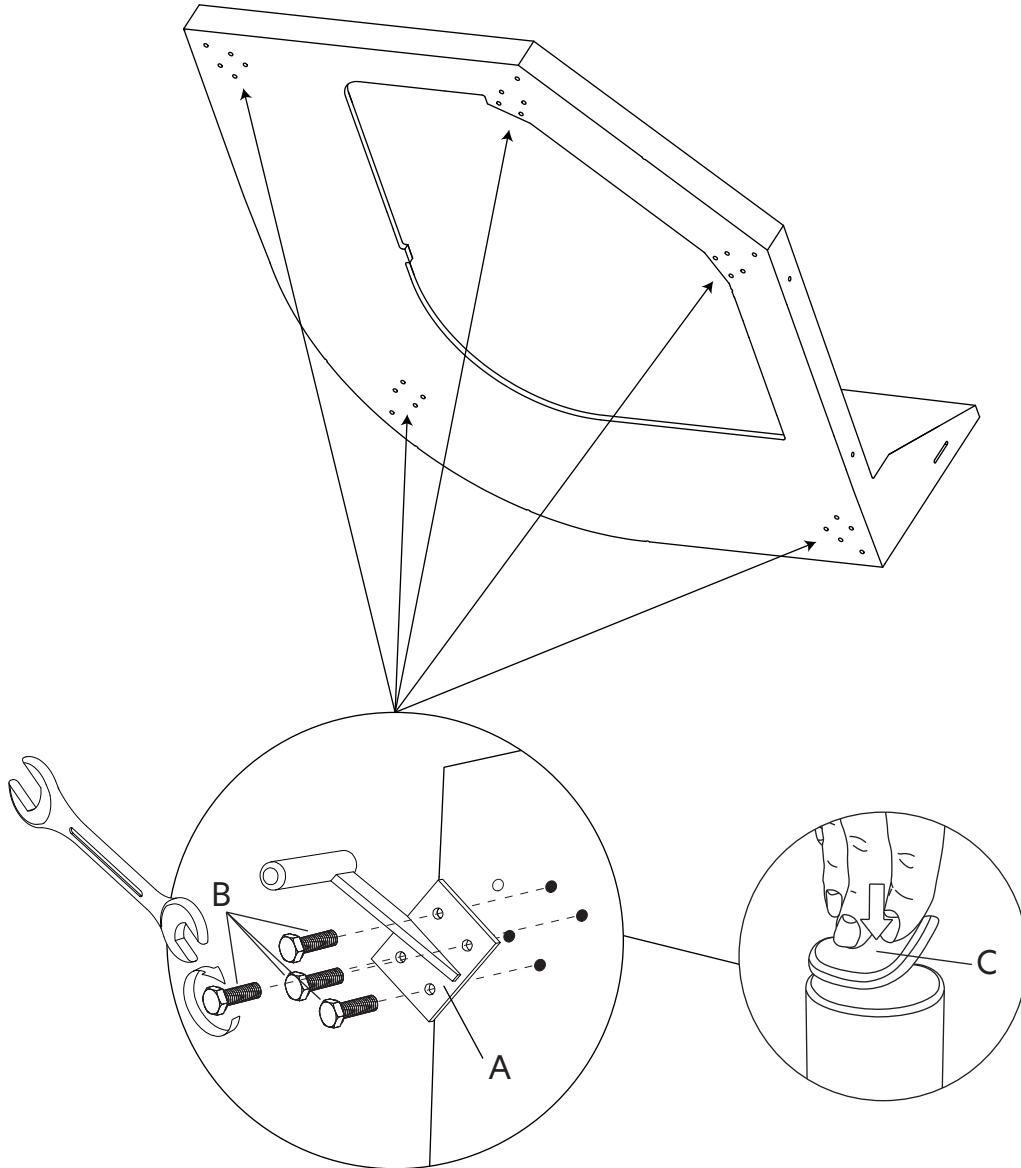

ASSEMBLY / MONTERING

Follow the instruction step by step.

Följ instruktionerna steg för steg.

1.

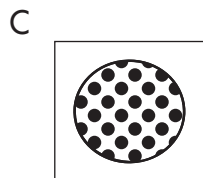
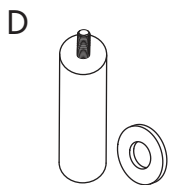
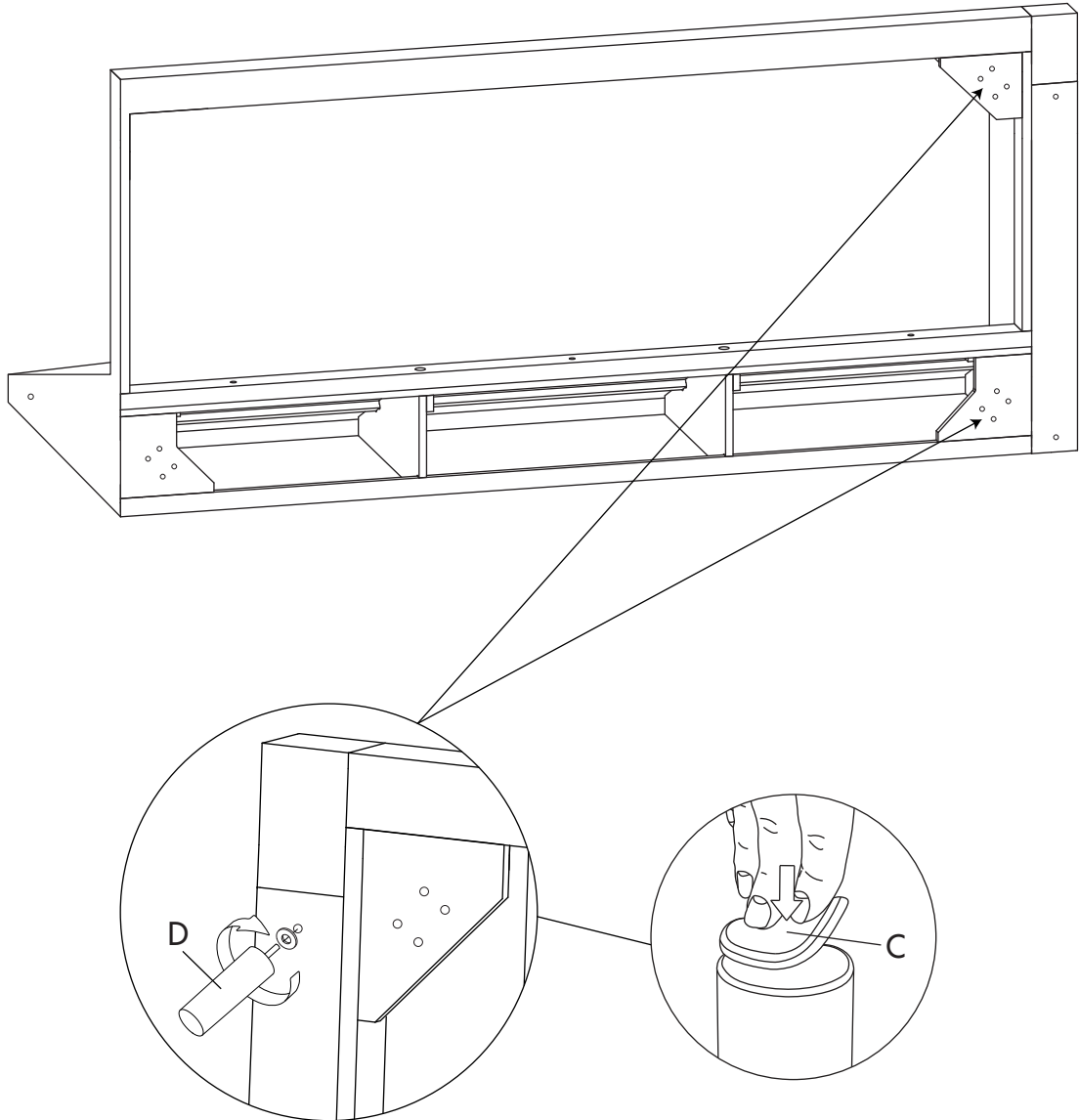

ASSEMBLY / MONTERING

Follow the instruction step by step.

Följ instruktionerna steg för steg.

2.

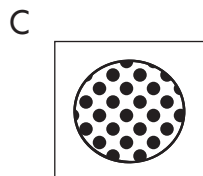
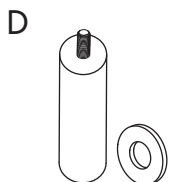
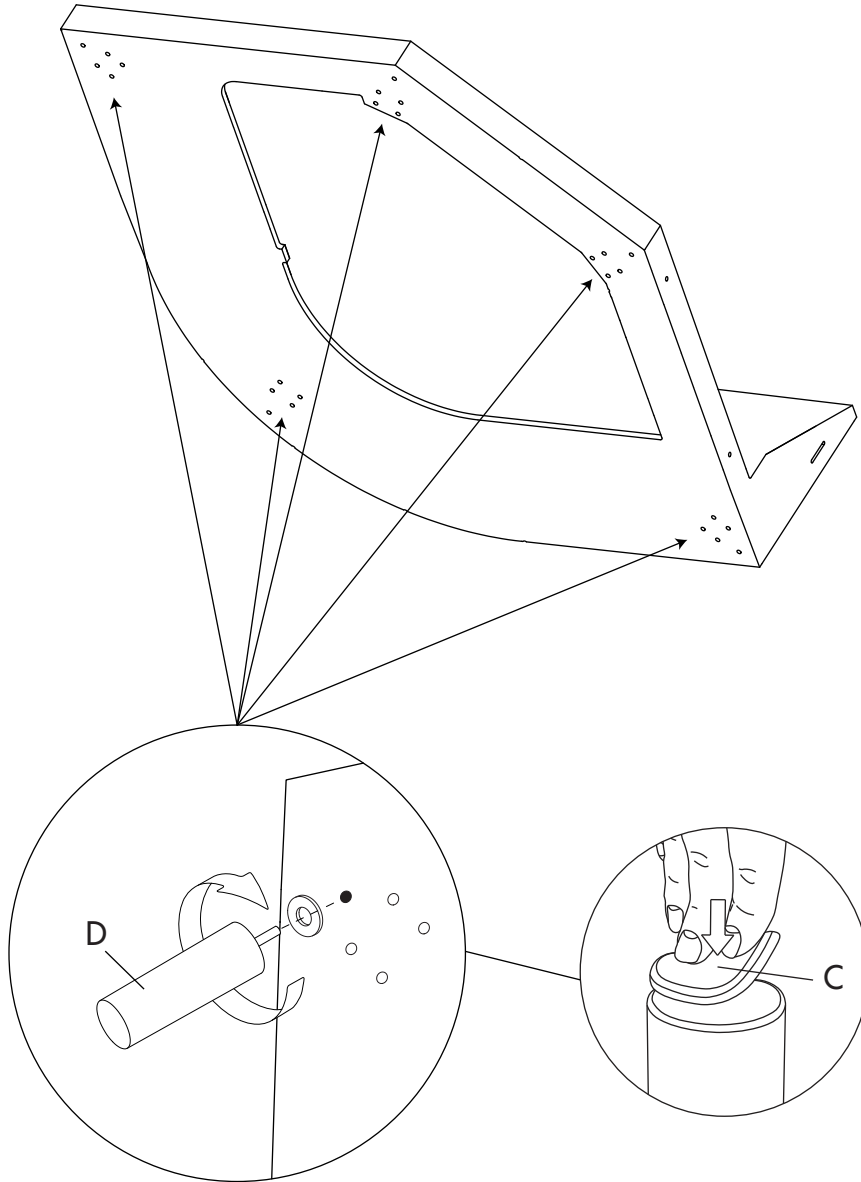

ASSEMBLY / MONTERING

Follow the instruction step by step.

Följ instruktionerna steg för steg.

3.

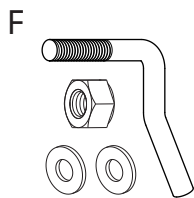
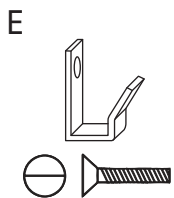
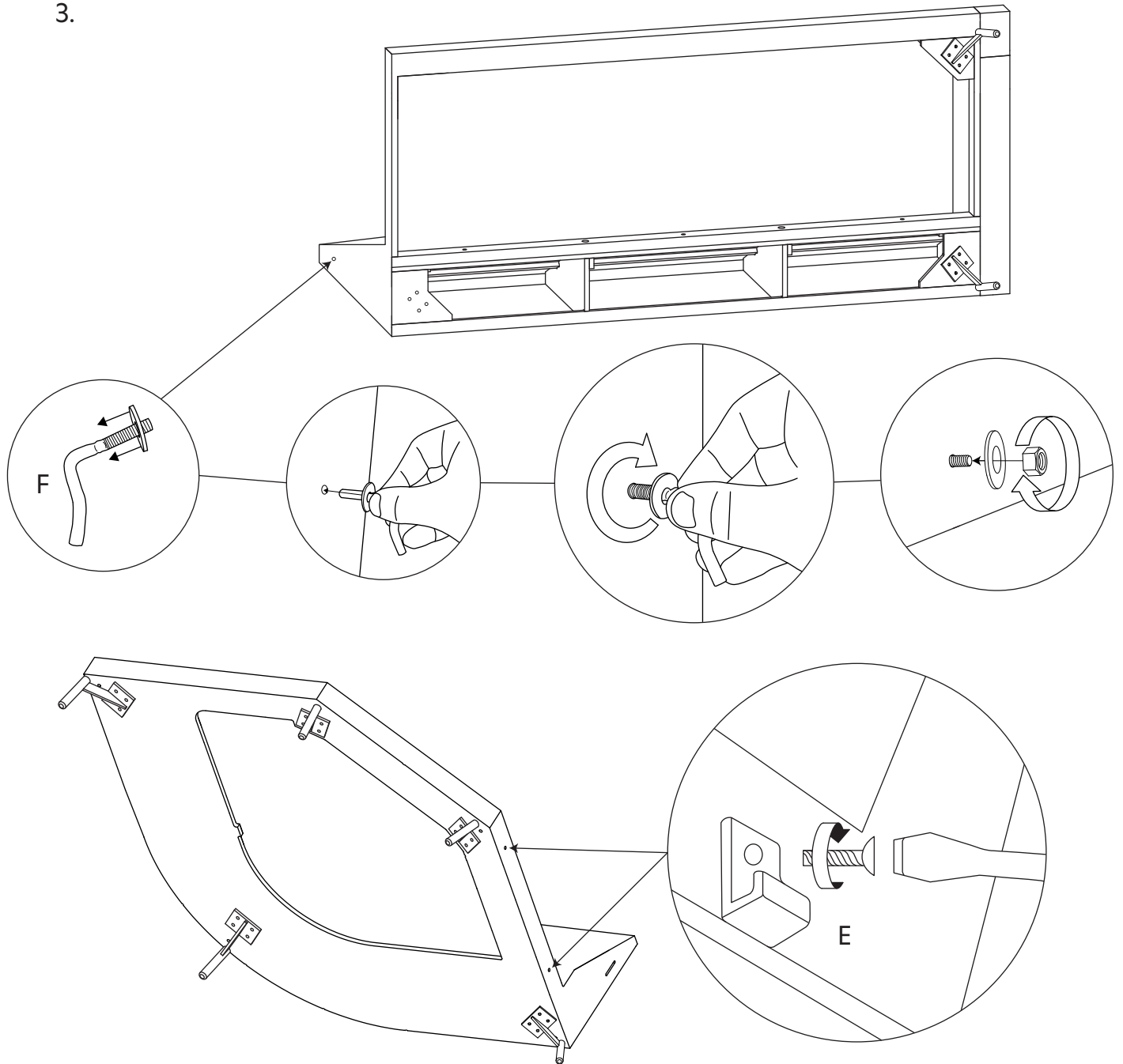

ASSEMBLY / MONTERING

Follow the instruction step by step.

Följ instruktionerna steg för steg.

4.

