

Assembly instruction

Bohem 3so, 3.5so

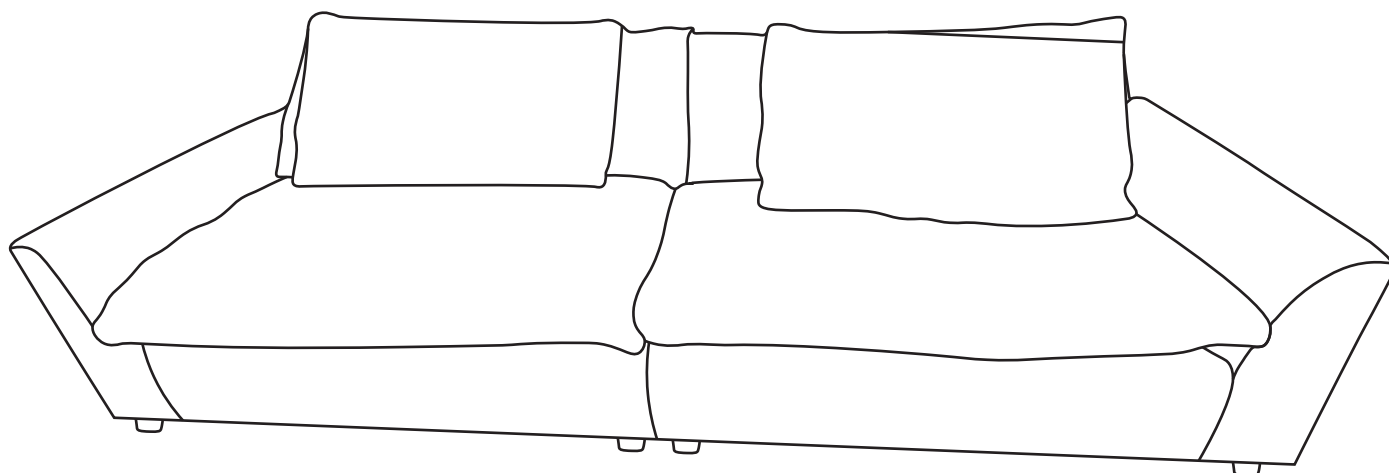

You will need



30 minutes

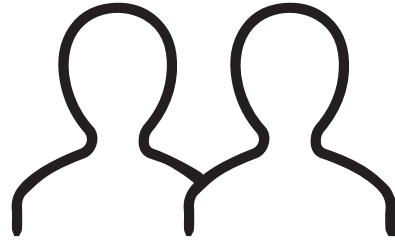

2 people

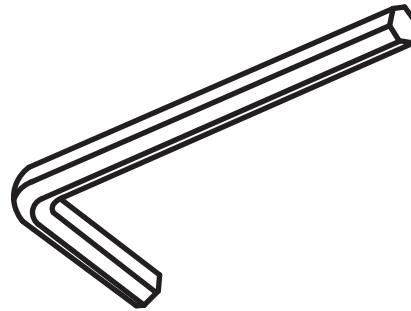
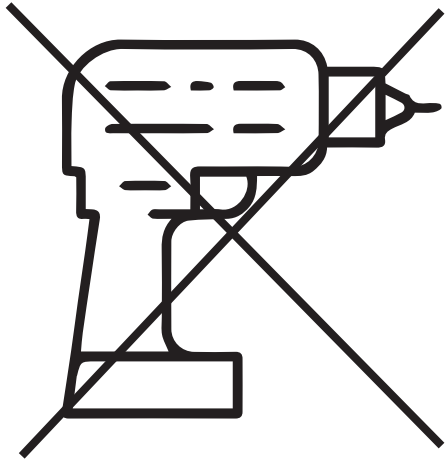

Key 2.5

Components

A

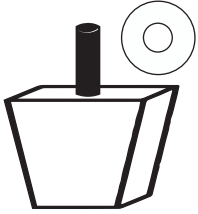

B

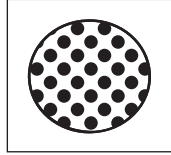

Nr	QTY	mm
A	8	H:50/80
B	8	
C	1	
D	1	
E	7	M4x20

C

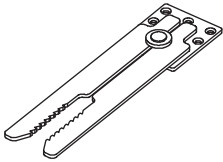

D

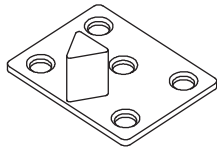

E



Mounting

Follow steps

1.

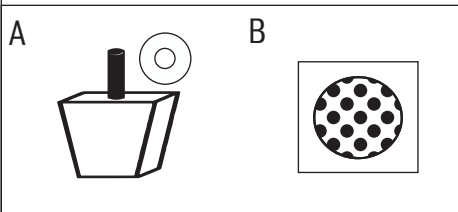
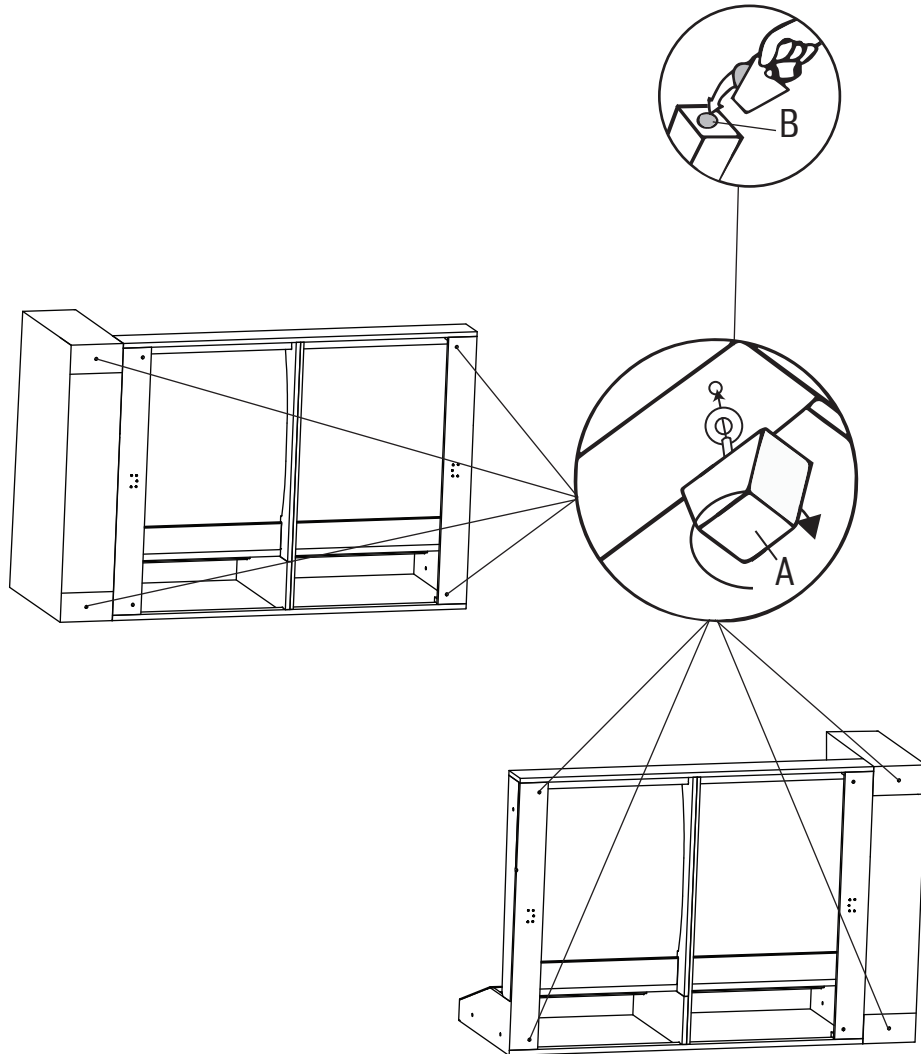

Mounting

Follow steps

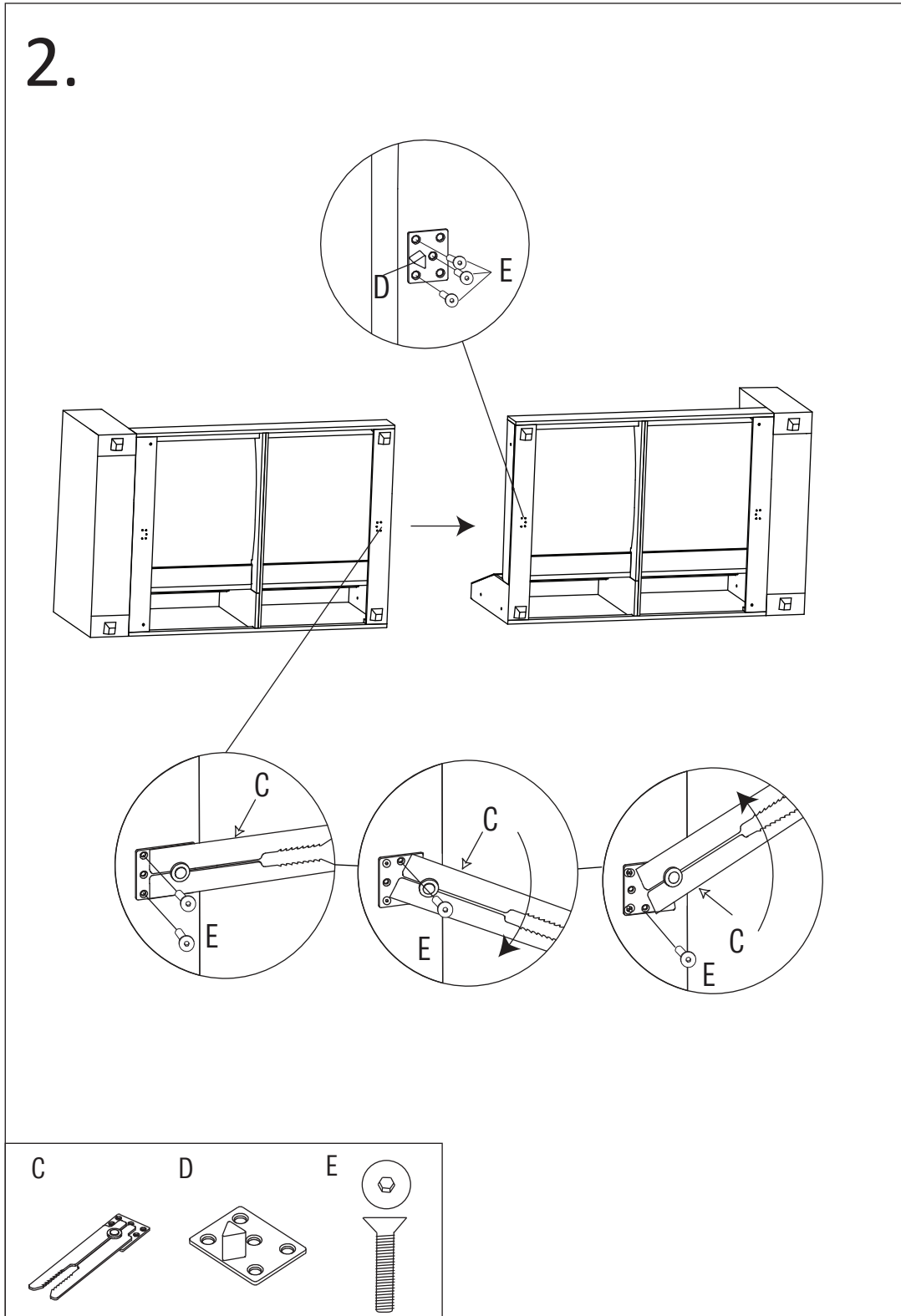

Mounting

Follow steps

3.

