

Assembly instruction

OLIVIA 2.5so, 3so

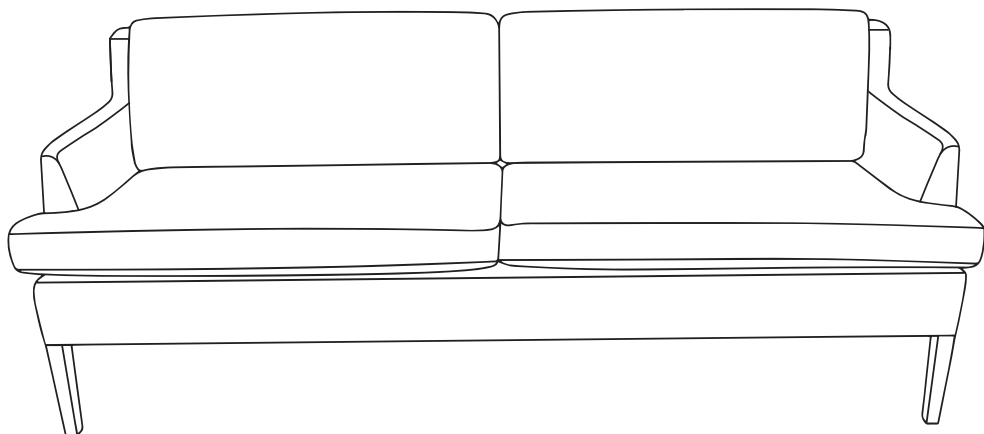

You need



30 minutes



2 people

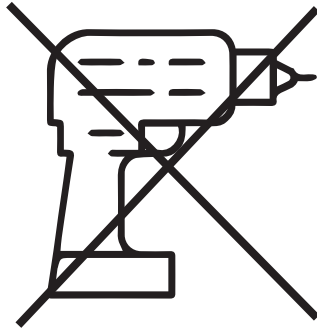

Components

A



B



Nr	QTY	mm
A	4	H:230
B	8	
C	4	
D	2	
E	2	
F	10	4x50mm

C

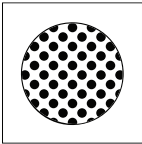

D

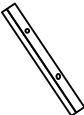

E

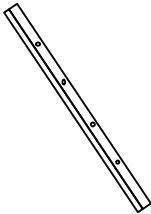

F



Mounting

Follow the instructions step by step

1.

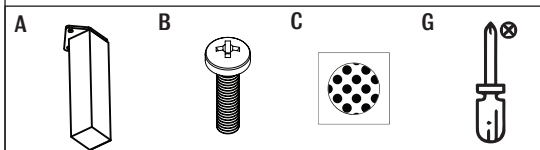
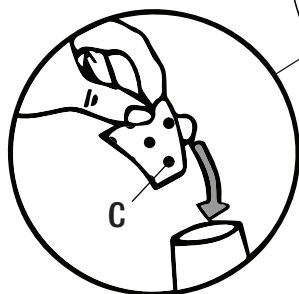
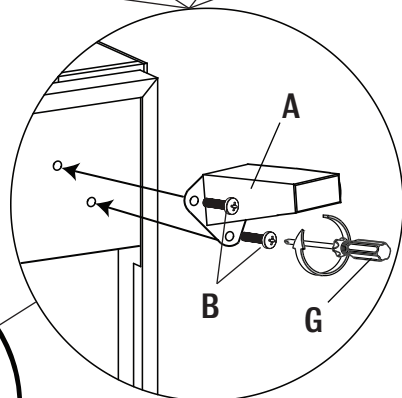
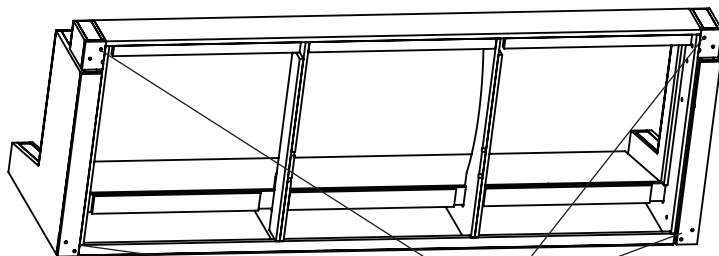

Mounting

Follow the instructions step by step

