

Assembly instruction

Kos 3XL

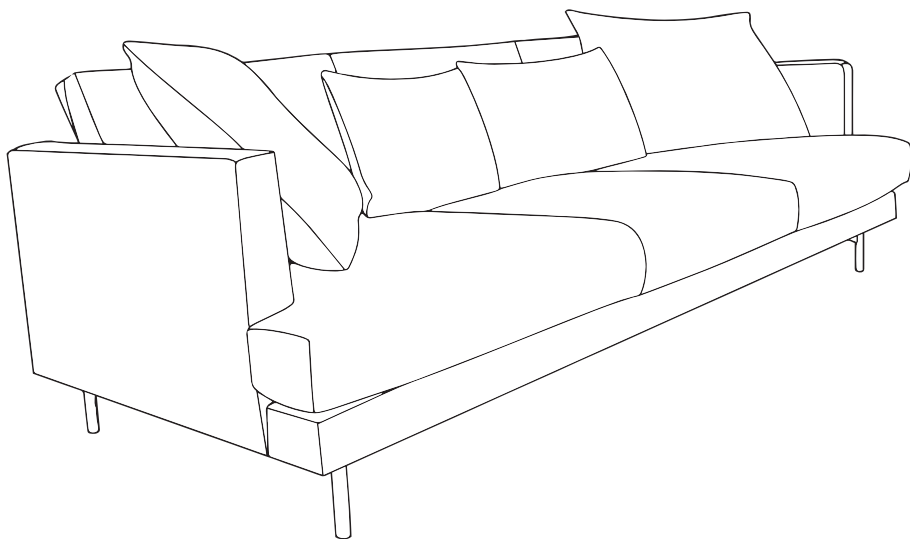

You need



30 minutes



1 person



Components

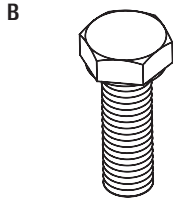
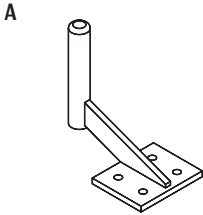

Nr	QTY	mm
A	4	H: 160
B	16	M8x30
C	4	

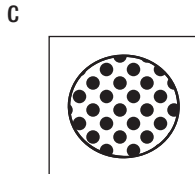
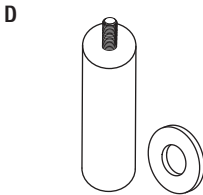
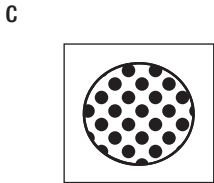

Nr	QTY	mm
D	4	H: 150
C	4	

Mounting

Follow the instructions step by step

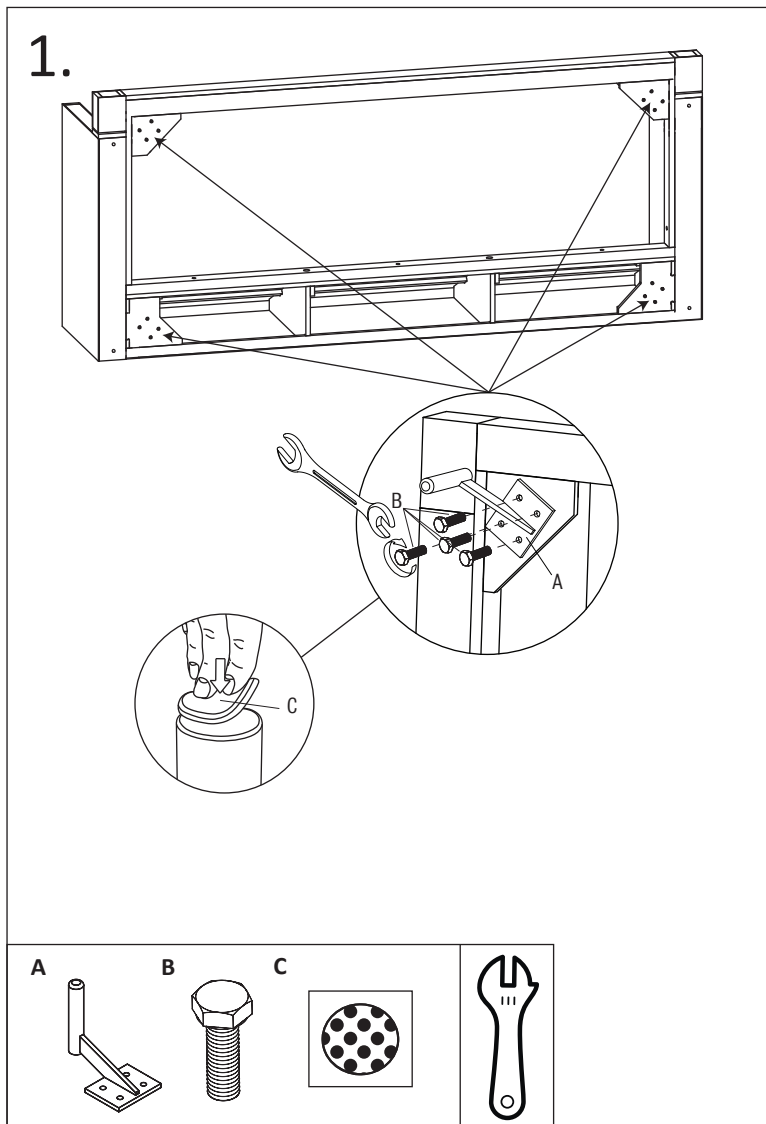

Mounting

Follow the instructions step by step

